

Info

Spannvorrichtungen 2

Tensioners 2

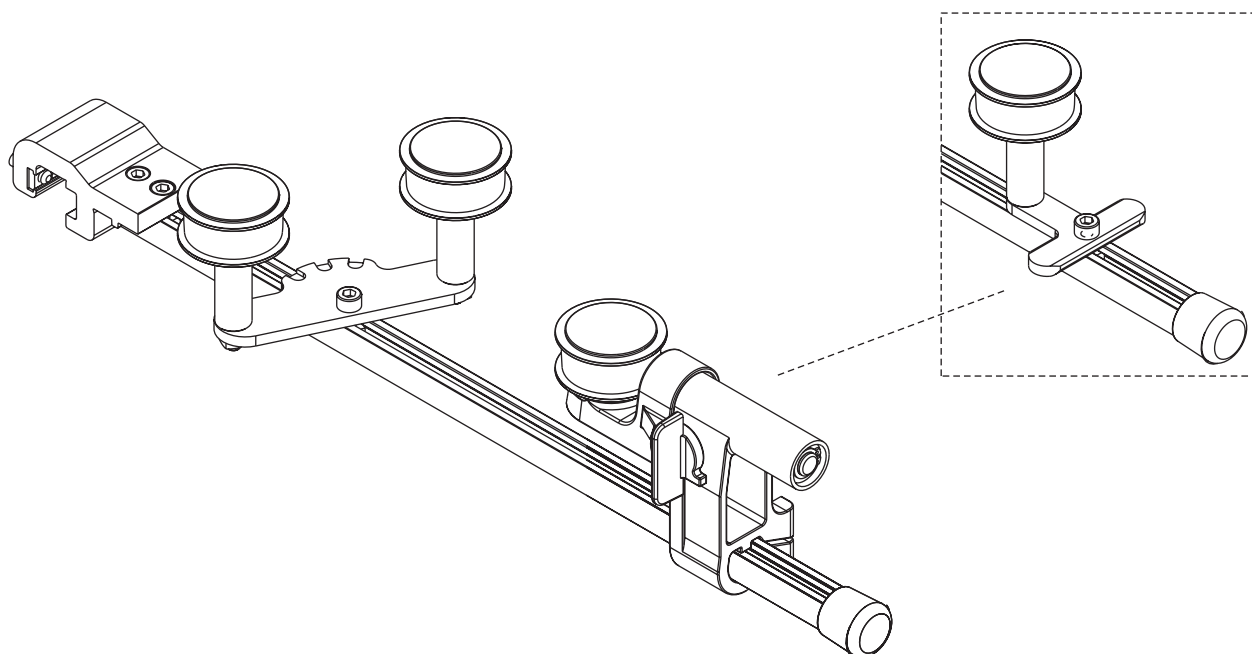

MEMMINGER-IRO GMBH
D-72277 DORNSTETTEN

022.900.035
27.04.04

Abbildung figure	Artikel-Nr.: Part-No.:	Bezeichnung	description
	022.000.076.01	Spannvorrichtung 2/470 für Band 1, Maß 21	tensioner 2/470 for belt 1, 21 high
	022.000.076.02	Spannvorrichtung 2/470 für Band 2, Maß 51	tensioner 2/470 for belt 2, 51 high
	022.000.076.03	Spannvorrichtung 2/470 für Band 3, Maß 81	tensioner 2/470 for belt 3, 81 high
	022.000.082.01	Doppel-Spannvorrichtung 2/470 für Band 1 + 2, Maß 21 + 51	twin tensioner 2/470 for belt 1 + 2, 21 + 51 high
	022.000.082.02	Doppel-Spannvorrichtung 2/470 für Band 3 + 4, Maß 81 + 111	twin tensioner 2/470 for belt 3 + 4, 81 + 111 high
	022.000.082.11	Doppel-Spannvorrichtung 2/470 für Band 1 + 2, Maß 21 + 51 Sonderausführung für MPF-30 und MPF-40	twin tensioner 2/470 for belt 1 + 2, 21 + 51 high special version for MPF-30 and MPF-40
	022.000.079.01	Federnde Spannvorrichtung 2/470 für Band 1, Maß 21	spring loaded tensioner 2/470 for belt 1, 21 high
	022.000.079.02	Federnde Spannvorrichtung 2/470 für Band 2, Maß 51	spring loaded tensioner 2/470 for belt 2, 51 high
	022.000.079.03	Federnde Spannvorrichtung 2/470 für Band 3, Maß 81	spring loaded tensioner 2/470 for belt 3, 81 high
	022.000.085.01	Federnde Doppel-Spannvorrichtung 2/470 für Band 1 + 2, Maß 21 + 51	spring loaded twin tensioner 2/470 for belt 1 + 2, 21 + 51 high
	022.000.085.02	Federnde Doppel-Spannvorrichtung 2/470 für Band 3 + 4, Maß 81 + 111	spring loaded twin tensioner 2/470 for belt 3 + 4, 81 + 111 high
	022.000.085.11	Federnde Doppel-Spannvorrichtung 2/470 für Band 1 + 2, Maß 21 + 51 Sonderausführung für MPF-30 und MPF-40	spring loaded twin tensioner 2/470 for belt 1 + 2, 21 + 51 high special version for MPF-30 and MPF-40

Abbildung figure	Artikel-Nr.: Part-No.:	Bezeichnung	description
	022.000.087.01	Einfach-Spannrolle 2/140 für Band 1, Maß 21, mit Halter	jockey pulley 2/140 for belt 1, 21 high, with support
	022.000.087.02	Einfach-Spannrolle 2/140 für Band 2, Maß 51, mit Halter	jockey pulley 2/140 for belt 2, 51 high, with support
	022.000.087.03	Einfach-Spannrolle 2/140 für Band 3, Maß 81, mit Halter	jockey pulley 2/140 for belt 3, 81 high, with support
	022.000.088.01	Einfach-Spannrolle 2/140 für Band 1 + 2, Maß 21 + 51, mit Halter	jockey pulley 2/140 for belt 1 + 2, 21 - 51 high, with support
	022.000.088.03	Einfach-Spannrolle 2/140 für Band 3 + 4, Maß 81 + 111, mit Halter	jockey pulley 2/140 for belt 3 + 4, 81 + 111 high, with support
	022.000.089.01	Einfach-Spannrolle 2/140 für Band 1 + 2 + 3, Maß 21 + 51 + 81, mit Halter	jockey pulley 2/140 for belt 1 + 2 + 3, 21 + 51 + 81 high, with support
	022.000.090.01	Doppel-Umlenkrolle 2/140 für Band 1, Maß 21, mit Halter	twin pulley 2/140 for belt 1, 21 high, with support
	022.000.090.02	Doppel-Umlenkrolle 2/140 für Band 2, Maß 51, mit Halter	twin pulley 2/140 for belt 2, 51 high, with support
	022.000.090.03	Doppel-Umlenkrolle 2/140 für Band 3, Maß 81, mit Halter	twin pulley 2/140 for belt 3, 81 high, with support
	022.000.091.01	Doppel-Umlenkrolle 2/140 für Band 1 + 2, Maß 21 + 51, mit Halter	twin pulley 2/140 for belt 1 + 2, 21 - 51 high, with support
	022.000.091.03	Doppel-Umlenkrolle 2/140 für Band 3 + 4, Maß 81 + 111, mit Halter	twin pulley 2/140 for belt 3 + 4, 81 + 111 high, with support
	022.000.092.01	Doppel-Umlenkrolle 2/140 für Band 1 + 2 + 3, Maß 21 + 51 + 81, mit Halter	twin pulley 2/140 for belt 1 + 2 + 3, 21 + 51 + 81 high, with support

Band / Tape 3
 Band / Tape 2
 Band / Tape 1



Band / Tape 4
 Band / Tape 3
 Band / Tape 2
 Band / Tape 1

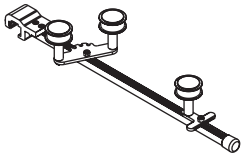
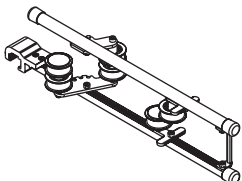
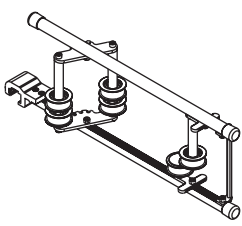
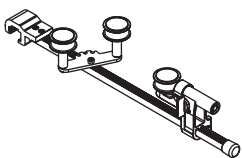
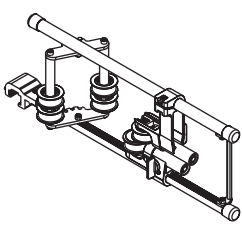
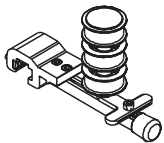
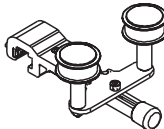
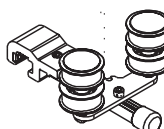
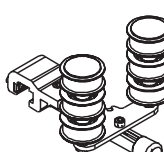
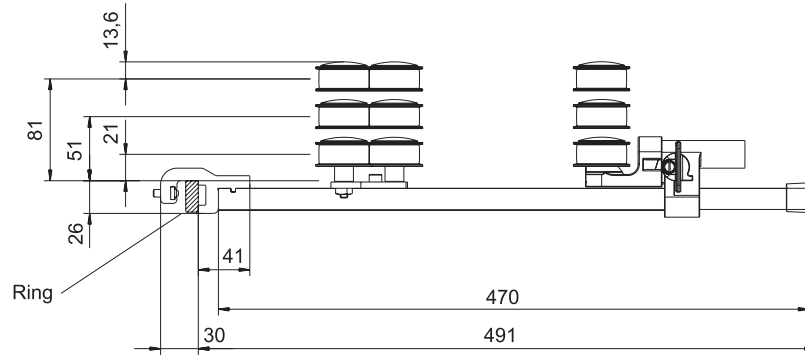
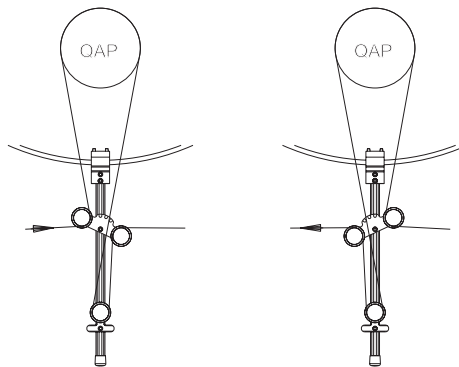
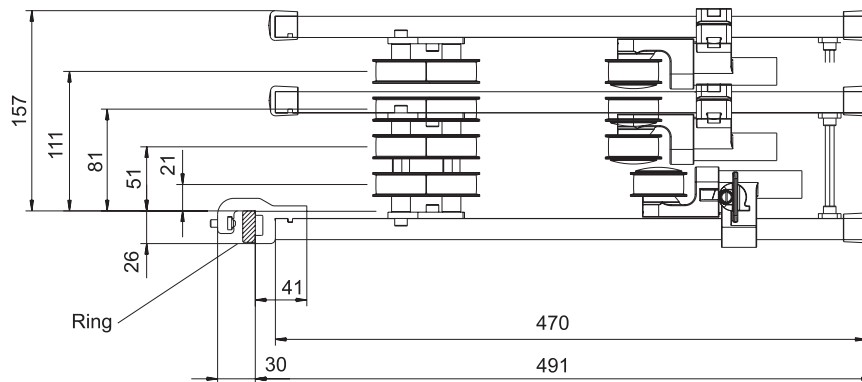

MEMMINGER-IRO GmbH
Postfach 1240
D-72277 DORNSTETTEN
Jakob-Mutz-Straße 7
D-72280 DORNSTETTEN

Tel.: (0)7443-281-0
Fax.: (0)7443-281-101
E-Mail: info@memminger-iro.de
Internet: www.memminger-iro.de